

1W High Power White LED
Technical Data Sheet

Part No.: HP60MWH

Features:

- ◇ High power LED type.
- ◇ Small package with high efficiency.
- ◇ High flux output and high luminance.
- ◇ Instant light (less than 100 ns).
- ◇ Very long operating life (up to 100k hours).
- ◇ Low voltage DC operated.
- ◇ Designed for high current operation.
- ◇ Low thermal resistance.
- ◇ Available in red, amber, yellow, green, blue, white, etc.
- ◇ Suitable for vapor-phase reflow, infrared reflow and wave solder processes.
- ◇ Computable with automatic placement equipment.
- ◇ Typical color temperature: 6500 K.
- ◇ Wide viewing angle: 135°.
- ◇ High reliable.
- ◇ The product itself will remain within RoHS compliant Version.

Descriptions:

- ◇ The HP60M series is available in soft red, orange, yellow, green, blue and white. Due to the package design, the LED has wide viewing angle and optimized light coupling by inter reflector. This feature makes the SMT LED ideal for light pipe application.
- ◇ This package LEDs are designed for high current operation and high flux output application. But the package's design features better thermal management characteristics than other LED solutions.
- ◇ Because of these advantages, this product have many applications such as internal & external lighting and automobile lamps, and large size LCD backlight, etc.

Applications:

- ◇ General illumination.
- ◇ Traffic signaling.
- ◇ Decorative lighting.
- ◇ Torch lighting.
- ◇ Interior and exterior automotive lighting.
- ◇ Substitution of micro incandescent lamps.
- ◇ Signal and symbol luminaire for orientation.
- ◇ Marker lights (e.g. steps, exit ways, etc).
- ◇ Decorative and entertainment lighting.
- ◇ Reading lights (car, bus, aircraft).
- ◇ Mini-accent / Uplighters / Downlighters / Orientation.
- ◇ Portable lighting (flashlight, bicycle lighting).
- ◇ Fiber Optic Alternative / Decorative / Entertainment lighting.
- ◇ Bollards / Security / Garden lighting.
- ◇ Cove / Under Shelf / Task lighting.
- ◇ Traffic signaling/Beacons / Rail crossing and Wayside lighting.
- ◇ Indoor / Outdoor Commercial and Residential Architectural lighting.
- ◇ Automotive rear combination lamps.
- ◇ Edge-lit signs (Exit, point of sale).
- ◇ Backlighting (illuminated advertising, general lighting) / LCD Backlights / Light Guides.

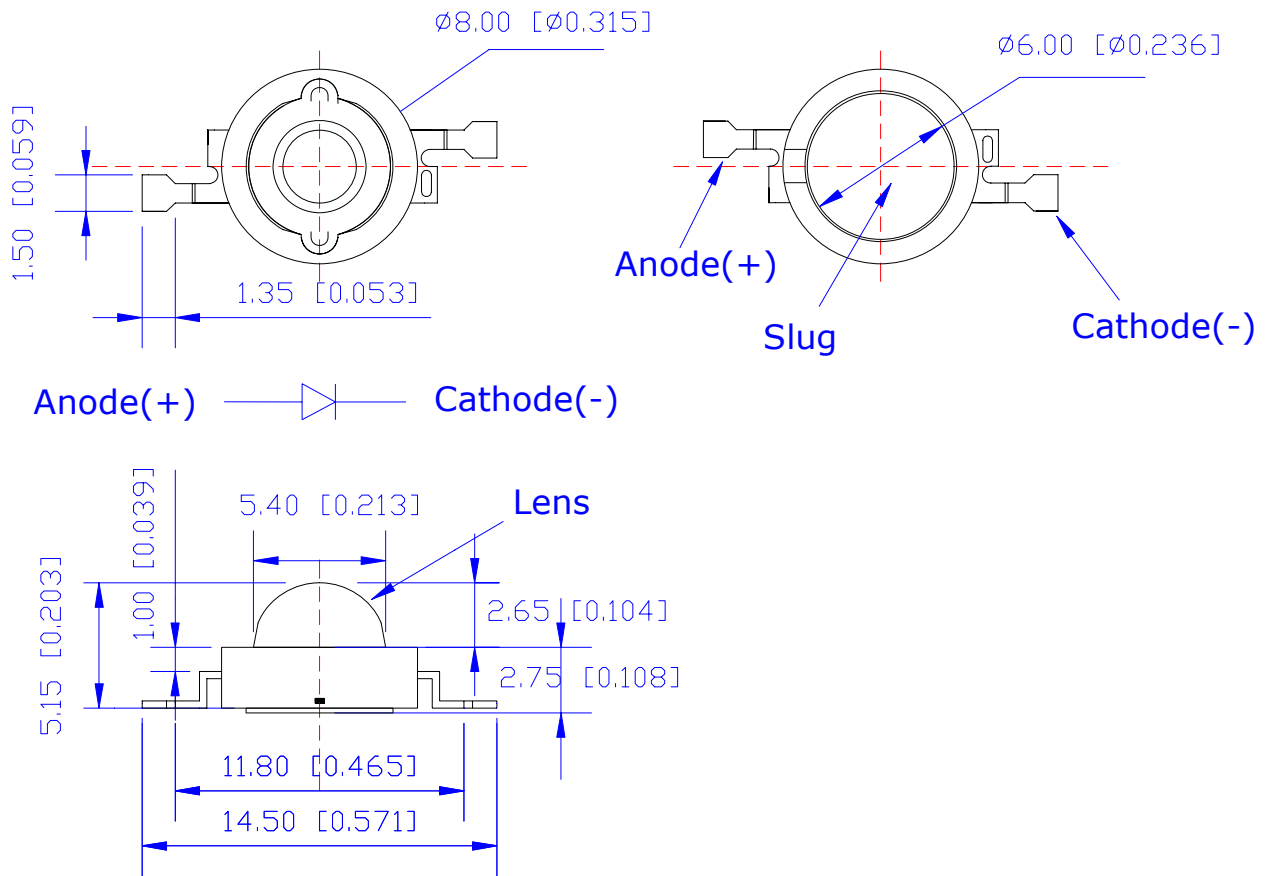
Package Dimensions:

Part No.	Chip Material	Source Color
HP60MWH	InGaN	White

Notes:

1. All dimensions are in millimeters.
2. Tolerance is ± 0.25 mm (.010") unless otherwise noted.
3. Specifications are subject to change without notice.

Absolute Maximum Ratings at Ta=25°C

Parameters	Symbol	Rating	Units
Power Dissipation	PD	1330	mW
Peak Pulse Forward Current (1/10 Duty Cycle, 0.1ms Pulse Width)	IFP	700	mA
DC Forward Current	IF	350	mA
Reverse Voltage	VR	5	V
LED Junction Temperature	Tj	125	°C
Operating Temperature Range	Topr	-40°C to +80°C	
Storage Temperature Range	Tstg	-40°C to +85°C	
Soldering Temperature	Tsol	260°C for 5 Seconds	

Notes:

1. It is strongly recommended that the temperature of lead be not higher than 55°C.
2. Proper current derating must be observed to maintain junction temperature below the maximum.
3. LEDs are not designed to be driven in reserve bias.

Electrical Optical Characteristics at Ta=25°C

Parameters	Symbol	Min.	Typ.	Max.	Unit	Test Condition
Luminous Flux [1]	Φ_v	120	130	---	lm	IF=350mA
Viewing Angle [2]	$2\theta_{1/2}$	---	135	---	Deg	IF=350mA
Chromaticity Coordinates [3]	X	---	0.31	---		IF=350mA
	Y	---	0.32	---		
Color Temperature	CCT	5500	6500	---	K	IF=350mA
Forward Voltage [4]	VF	2.80	3.40	3.80	V	IF=350mA
Reverse Current	IR	---	---	10	μ A	VR=5V

Notes:

1. Luminous Intensity Measurement allowance is $\pm 10\%$.
2. $\theta_{1/2}$ is the off-axis angle at which the luminous intensity is half the axial luminous intensity.
3. X, Y coordination for white light bin areas refer to EHP-A08 series White and Warm White Binning (DSE-A08-001).
4. Forward Voltage measurement tolerance: $\pm 0.10V$.

Typical Electrical-Optical Characteristics Curves (25°C Ambient Temperature Unless Otherwise Noted)

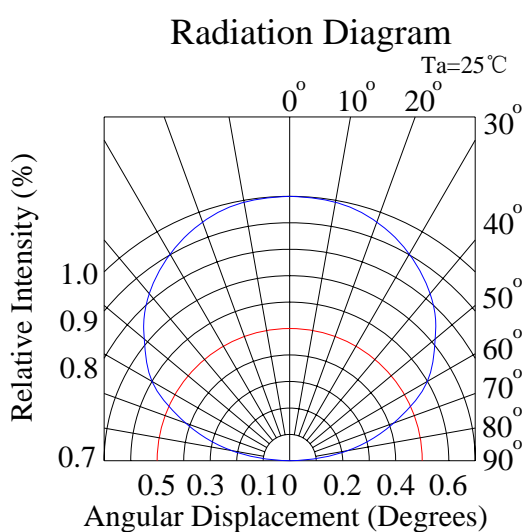
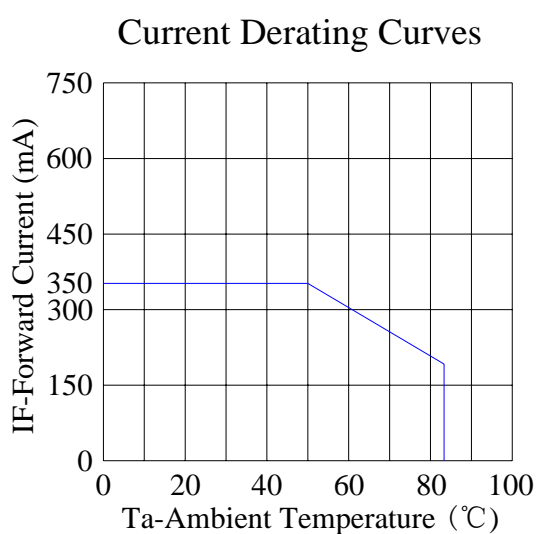
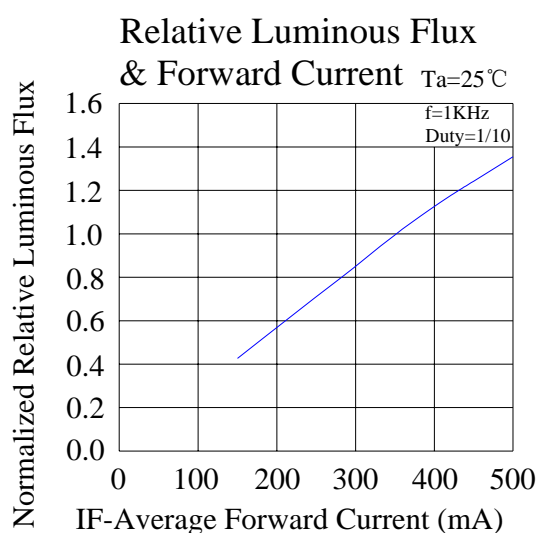
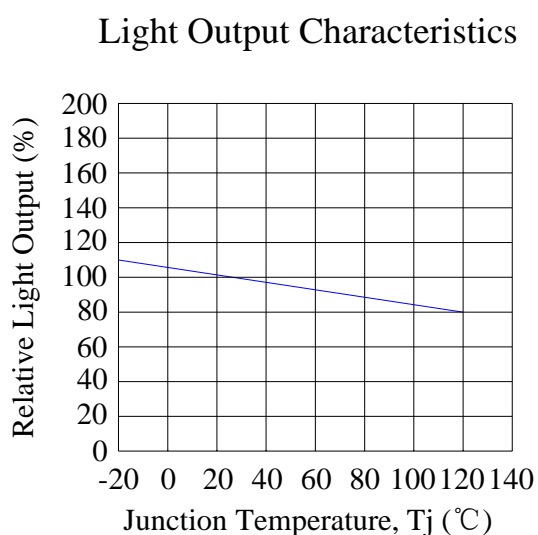
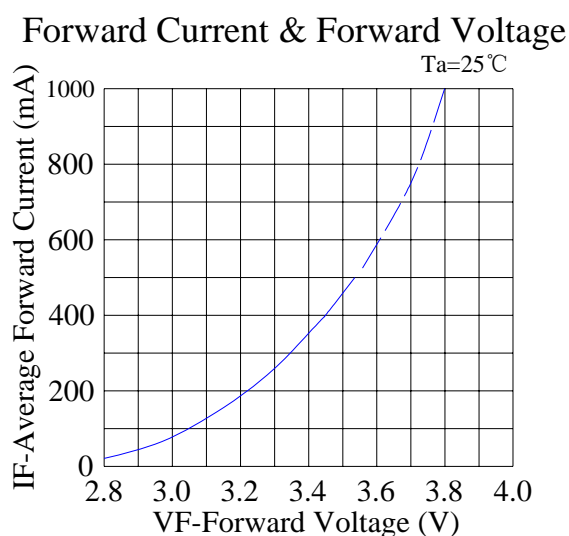
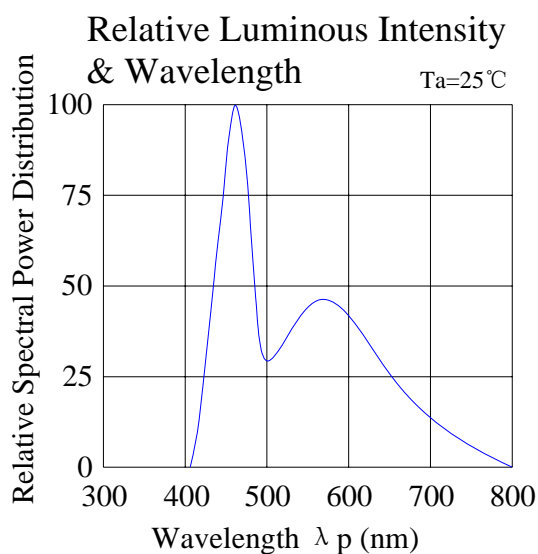

Reliability Test Items and Conditions:

The reliability of products shall be satisfied with items listed below:

Confidence level: 90%.

LTPD: 10%.

1) Test Items and Results:

No.	Test Item	Test Hours/Cycles	Test Conditions	Sample Size	Ac/Re
1	Resistance to Soldering Heat	6 Min	Tsld=260±5°C, Min. 5sec	25pcs	0/1
2	Thermal Shock	300 Cycles	H: +100°C 5min ∫ 10 sec L: -10°C 5min	25pcs	0/1
3	Temperature Cycle	300 Cycles	H: +100°C 15min ∫ 5min L: -40°C 15min	25pcs	0/1
4	High Temperature Storage	1000Hrs.	Temp: 100°C	25pcs	0/1
5	DC Operating Life	1000Hrs.	IF=350mA	25pcs	0/1
6	Low Temperature Storage	1000Hrs.	Temp: -40°C	25pcs	0/1
7	High Temperature/ High Humidity	1000Hrs.	85°C/85%RH	25pcs	0/1

2) Criteria for Judging the Damage:

Item	Symbol	Test Conditions	Criteria for Judgment	
			Min	Max
Forward Voltage	VF	IF=350mA	---	F.V.*)×1.1
Reverse Current	IR	VR=5V	---	F.V.*)×2.0
Luminous Intensity	IV	IF=350mA	F.V.*)×0.7	---

*) F.V.: First Value.

Please read the following notes before using the product:

1. Over-current-proof

Customer must apply resistors for protection, otherwise slight voltage shift will cause big current change (Burn out will happen).

2. Storage

- 2.1 Do not open moisture proof bag before the products are ready to use.
- 2.2 Before opening the package, the LEDs should be kept at 30°C or less and 80%RH or less.
- 2.3 The LEDs should be used within a year.
- 2.4 After opening the package, the LEDs should be kept at 30°C or less and 60%RH or less.
- 2.5 The LEDs should be used within 168 hours (7 days) after opening the package.
- 2.6 If the moisture adsorbent material has fabled away or the LEDs have exceeded the storage time, baking treatment should be performed using the following conditions. Baking treatment: 60±5°C for 24 hours.

3. Soldering Condition

When soldering, for Lamp without stopper type and must be leave a minimum of 3mm clearance from the base of the lens to the soldering point.

To avoided the Epoxy climb up on lead frame and was impact to non-soldering problem, dipping the lens into the solder must be avoided.

Do not apply any external stress to the lead frame during soldering while the LED is at high temperature.

Recommended soldering conditions:

Soldering Iron		Wave Soldering	
Temperature	300°C Max.	Pre-heat	100°C Max.
Soldering Time	3 sec. Max. (one time only)	Pre-heat Time	60 sec. Max.
		Solder Wave	260°C Max.
		Soldering Time	5 sec. Max.

Note: Excessive soldering temperature and / or time might result in deformation of the LED lens or catastrophic failure of the LED.

4. Soldering Iron

Each terminal is to go to the tip of soldering iron temperature less than 260°C for 5 seconds within once in less than the soldering iron capacity 25W. Leave two seconds and more intervals, and do soldering of each terminal. Be careful because the damage of the product is often started at the time of the hand solder.

5. Repairing

Repair should not be done after the LEDs have been soldered. When repairing is unavoidable, a double-head soldering iron should be used (as below figure). It should be confirmed beforehand whether the characteristics of the LEDs will or will not be damaged by repairing.

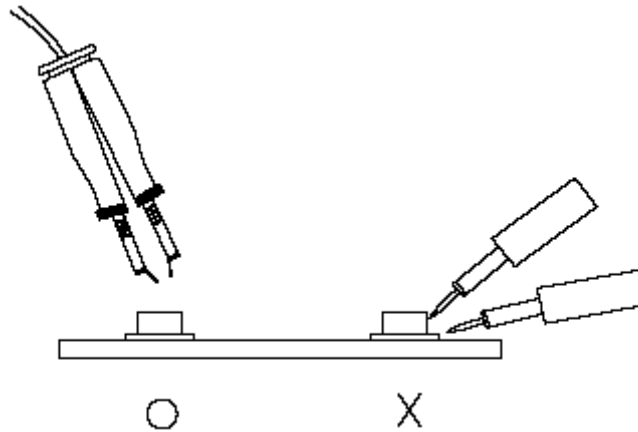

6. Caution in ESD

Static Electricity and surge damages the LED. It is recommended to use a wrist band or anti-electrostatic glove when handling the LED. All devices, equipment and machinery must be properly grounded.