

Subminiature Axial White Chip LED  
Technical Data Sheet

Part No.: AR180W-W2-1C/TR5



## Features:

- 2.15×2.40mm with 1.80mm lens.
- Small double-end package.
- EIA Std. package.
- Mono-color type.
- High reliability.
- Low forward voltage.
- Compatible with automatic placement equipment.
- The product itself will remain within RoHS compliant version.

## Descriptions:

The AR180 SMD taping is much smaller than leaded components. Thus enable smaller board size. Higher packing density. Reduced storage space and finally smaller equipment to be obtained.

Besides, light weight makes them ideal for miniature applications.

Furthermore by automation assembly machines the accuracy is anticipated.

## Applications:

Small indicator for indoor applications.

Flat backlight for LCD, switches and symbols.

Indicator and backlight in office equipment.

Indicator and backlight for battery driven equipment.

Indicator and backlight for audio and video equipment.

Automotive: Backlighting in dashboards and switches.

Telecommunication: Indicator and backlighting in telephone and fax.

### Package Dimension:

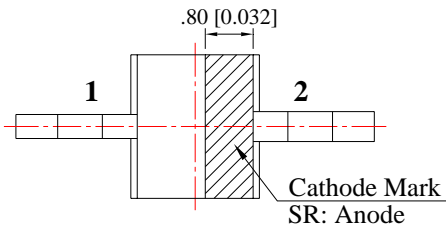
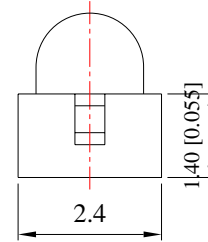
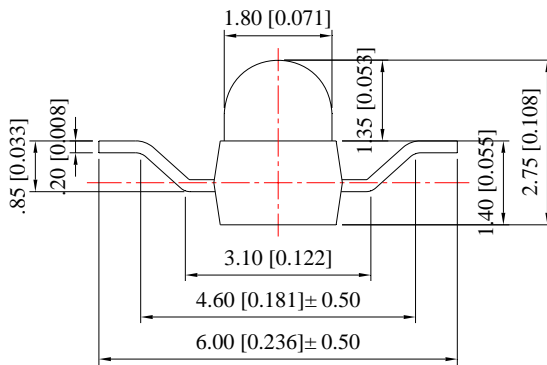
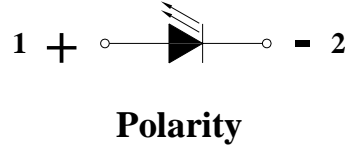
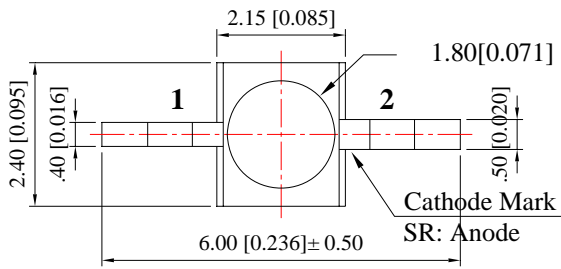

Unit: mm  
Tolerance: ± 0.10 mm

| Part No.         | Chip Material | Lens Color      | Source Color |
|------------------|---------------|-----------------|--------------|
| AR180W-W2-1C/TR5 | InGaN         | Yellow Diffused | White        |

### Notes:

1. All dimensions are in millimeters (inches).
2. Tolerance is ± 0.10mm (.004") unless otherwise specified.
3. Specifications are subject to change without notice.

**Absolute Maximum Ratings at Ta=25**

| Parameters   | Symbol | Max               | Unit |
|--|--------|-------------------|------|
| Power Dissipation  | PD     | 95                | mW   |
| Peak Forward Current<br>(1/10 Duty Cycle, 0.1ms Pulse Width) | IFP    | 100               | mA   |
| Continuous Forward Current                                   | IF     | 25                | mA   |
| Reverse Voltage  | VR     | 5                 | V    |
| Electrostatic Discharge (HBM)                                | ESD    | 400               | V    |
| Operating Temperature Range                                  | Topr   | -40 to +80        |      |
| Storage Temperature Range                                    | Tstg   | -40 to +85        |      |
| Soldering Temperature  | Tsld   | 260 for 5 Seconds |      |

**Electrical Optical Characteristics at Ta=25**

| Parameters               | Symbol            | Min. | Typ. | Max. | Unit | Test Condition   |
|--------------------------|-------------------|------|------|------|------|------------------|
| Luminous Intensity *     | IV                | 1500 | 3000 | ---  | mcd  | IF=20mA (Note 1) |
| Viewing Angle *          | 2θ <sub>1/2</sub> | ---  | 60   | ---  | Deg  | IF=20mA (Note 2) |
| Chromaticity Coordinates | x                 | ---  | 0.31 | ---  |      | IF=20mA (Note 3) |
|                          | y                 | ---  | 0.32 | ---  |      |                  |
| Color Temperature        | CCT               | 5000 | 6500 | ---  | K    | IF=20mA          |
| Forward Voltage          | VF                | 2.80 | 3.40 | 3.80 | V    | IF=20mA          |
| Reverse Current          | IR                | ---  | ---  | 10   | μA   | VR=5V            |

**Notes:**

- Luminous Intensity Measurement allowance is  $\pm 10\%$ .
- $\theta_{1/2}$  is the off-axis angle at which the luminous intensity is half the axial luminous intensity.
- It use many parameters that correspond to the CIE 1931 2°. X, Y, and Z are CIE 1931 2° values of Red, Green and Blue content of the measurement.

Typical Electrical / Optical Characteristics Curves  
(25 Ambient Temperature Unless Otherwise Noted)

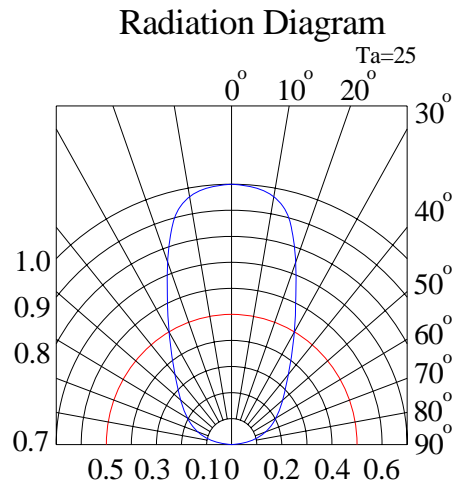
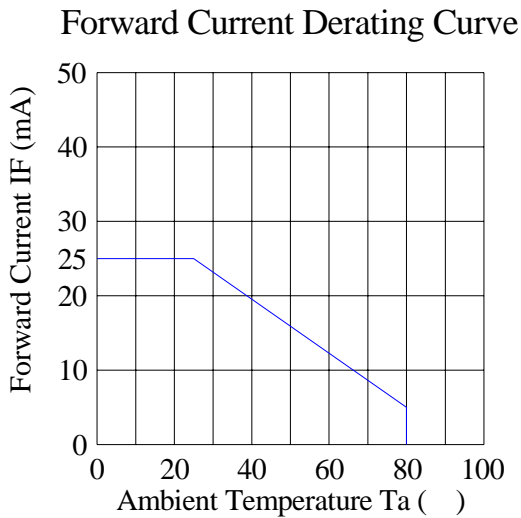
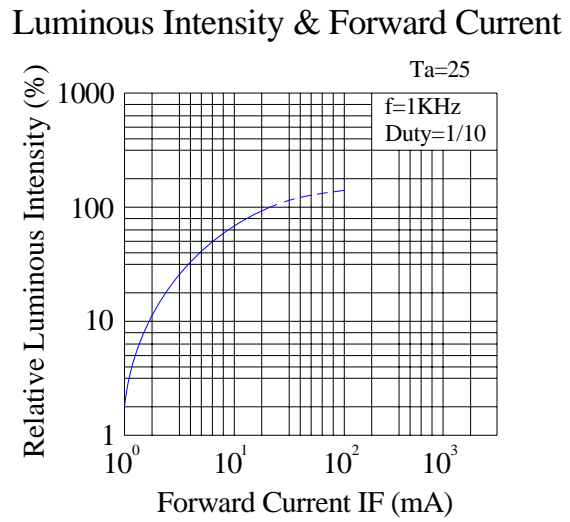
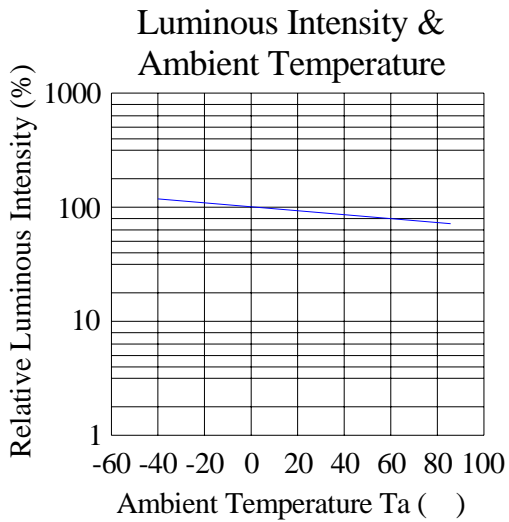
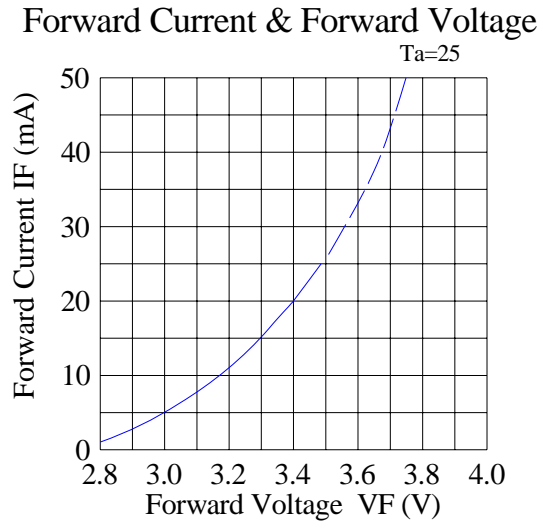
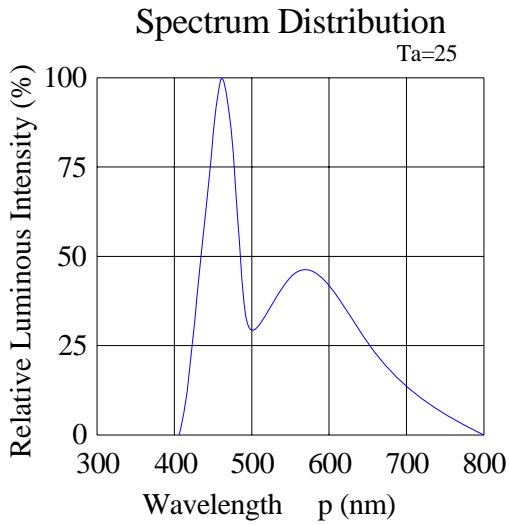

### CIE 1931 Chromaticity Diagram:

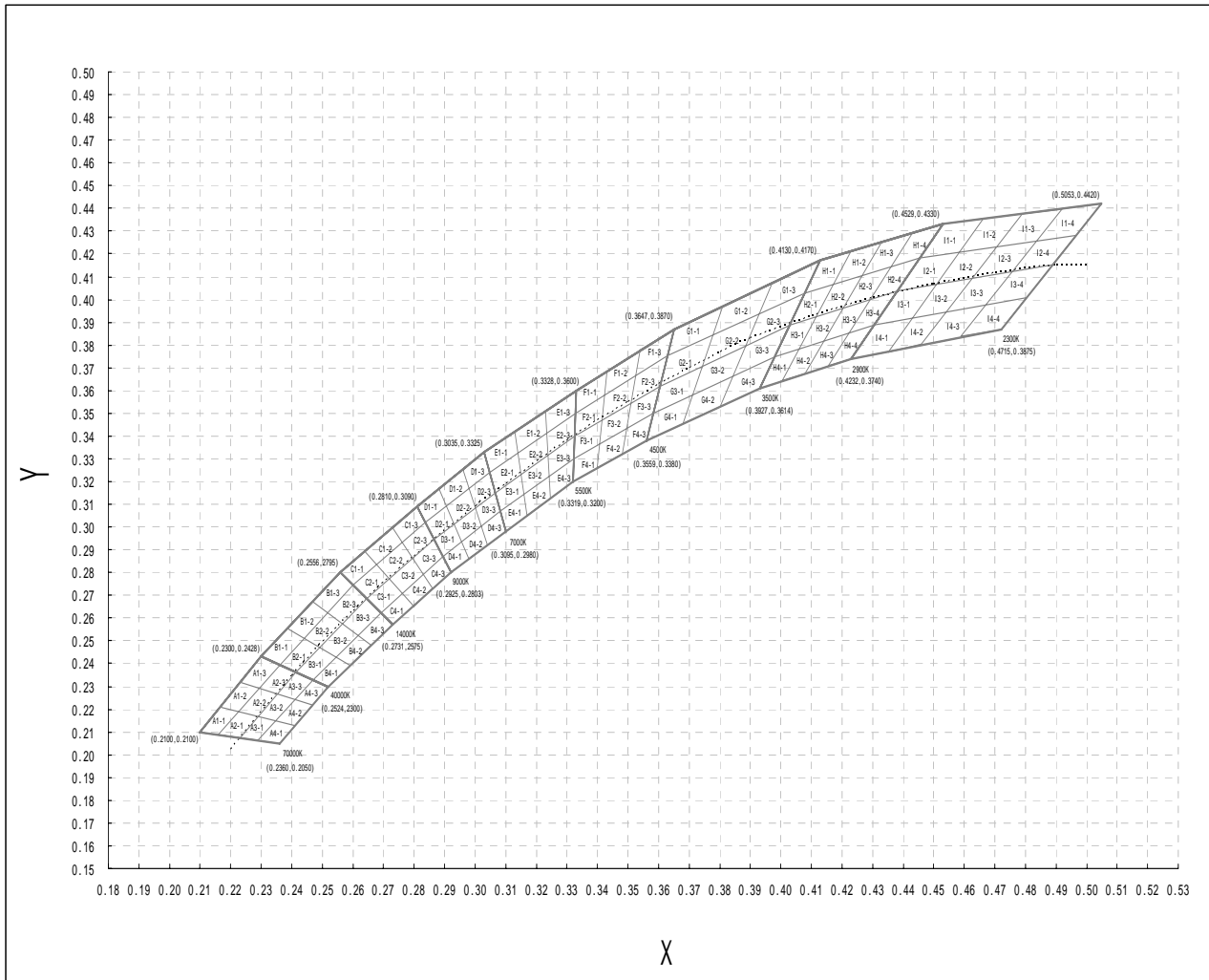

### W2:

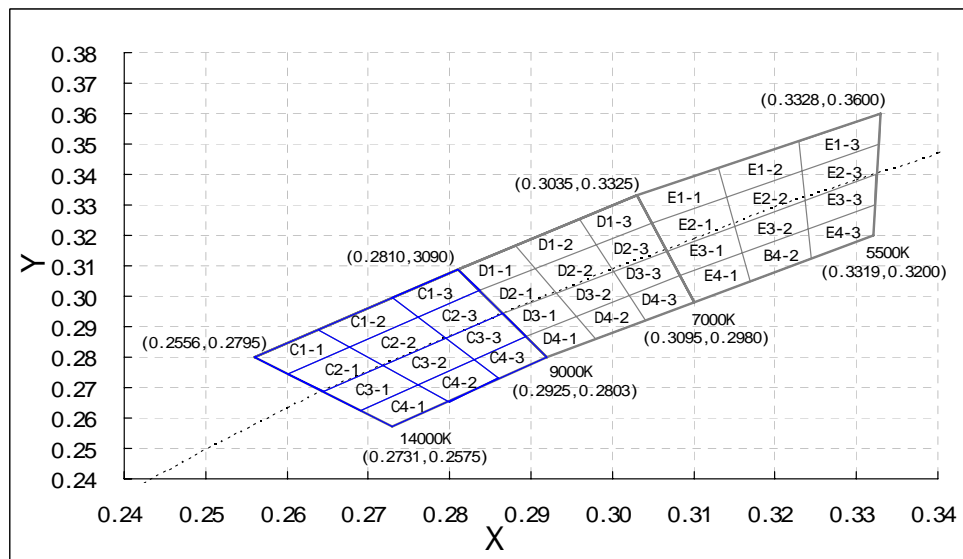

### Chromaticity Coordinates Specifications for Bin Rank:

| Bin Code | Left x | Left y | Top x  | Top y  | Right x | Right y | Bottom x | Bottom y |
|----------|--------|--------|--------|--------|---------|---------|----------|----------|
| C1-1     | 0.2560 | 0.2800 | 0.2640 | 0.2890 | 0.2680  | 0.2830  | 0.2600   | 0.2740   |
| C2-1     | 0.2600 | 0.2740 | 0.2680 | 0.2830 | 0.2720  | 0.2770  | 0.2640   | 0.2690   |
| C3-1     | 0.2640 | 0.2690 | 0.2720 | 0.2770 | 0.2760  | 0.2710  | 0.2690   | 0.2630   |
| C4-1     | 0.2690 | 0.2630 | 0.2760 | 0.2710 | 0.2800  | 0.2650  | 0.2730   | 0.2570   |
| C1-2     | 0.2640 | 0.2890 | 0.2730 | 0.2990 | 0.2760  | 0.2930  | 0.2680   | 0.2830   |
| C2-2     | 0.2680 | 0.2830 | 0.2760 | 0.2930 | 0.2790  | 0.2860  | 0.2720   | 0.2770   |
| C3-2     | 0.2720 | 0.2770 | 0.2790 | 0.2860 | 0.2830  | 0.2790  | 0.2760   | 0.2710   |
| C4-2     | 0.2760 | 0.2710 | 0.2830 | 0.2790 | 0.2860  | 0.2730  | 0.2800   | 0.2650   |
| C1-3     | 0.2730 | 0.2990 | 0.2810 | 0.3090 | 0.2840  | 0.3020  | 0.2760   | 0.2930   |
| C2-3     | 0.2760 | 0.2930 | 0.2840 | 0.3020 | 0.2870  | 0.2950  | 0.2790   | 0.2860   |
| C3-3     | 0.2790 | 0.2860 | 0.2870 | 0.2950 | 0.2900  | 0.2870  | 0.2830   | 0.2790   |
| C4-3     | 0.2830 | 0.2790 | 0.2900 | 0.2870 | 0.2920  | 0.2800  | 0.2860   | 0.2730   |
| D1-1     | 0.2810 | 0.3090 | 0.2880 | 0.3170 | 0.2910  | 0.3090  | 0.2840   | 0.3020   |
| D2-1     | 0.2840 | 0.3020 | 0.2910 | 0.3090 | 0.2930  | 0.3020  | 0.2870   | 0.2950   |
| D3-1     | 0.2870 | 0.2950 | 0.2930 | 0.3020 | 0.2960  | 0.2940  | 0.2900   | 0.2870   |
| D4-1     | 0.2900 | 0.2870 | 0.2960 | 0.2940 | 0.2980  | 0.2860  | 0.2920   | 0.2800   |
| D1-2     | 0.2880 | 0.3170 | 0.2960 | 0.3250 | 0.2980  | 0.3170  | 0.2910   | 0.3090   |
| D2-2     | 0.2910 | 0.3090 | 0.2980 | 0.3170 | 0.3000  | 0.3080  | 0.2930   | 0.3020   |
| D3-2     | 0.2930 | 0.3020 | 0.3000 | 0.3080 | 0.3020  | 0.3000  | 0.2960   | 0.2940   |
| D4-2     | 0.2960 | 0.2940 | 0.3020 | 0.3000 | 0.3040  | 0.2920  | 0.2980   | 0.2860   |
| D1-3     | 0.2960 | 0.3250 | 0.3030 | 0.3330 | 0.3050  | 0.3240  | 0.2980   | 0.3170   |
| D2-3     | 0.2980 | 0.3170 | 0.3050 | 0.3240 | 0.3070  | 0.3150  | 0.3000   | 0.3080   |
| D3-3     | 0.3000 | 0.3080 | 0.3070 | 0.3150 | 0.3080  | 0.3070  | 0.3020   | 0.3000   |
| D4-3     | 0.3020 | 0.3000 | 0.3080 | 0.3070 | 0.3100  | 0.2980  | 0.3040   | 0.2920   |
| E1-1     | 0.3030 | 0.3330 | 0.3130 | 0.3420 | 0.3140  | 0.3330  | 0.3050   | 0.3240   |
| E2-1     | 0.3050 | 0.3240 | 0.3140 | 0.3330 | 0.3150  | 0.3240  | 0.3070   | 0.3150   |
| E3-1     | 0.3070 | 0.3150 | 0.3150 | 0.3240 | 0.3160  | 0.3140  | 0.3080   | 0.3070   |
| E4-1     | 0.3080 | 0.3070 | 0.3160 | 0.3140 | 0.3170  | 0.3050  | 0.3100   | 0.2980   |
| E1-2     | 0.3130 | 0.3420 | 0.3230 | 0.3510 | 0.3230  | 0.3410  | 0.3140   | 0.3330   |
| E2-2     | 0.3140 | 0.3330 | 0.3230 | 0.3410 | 0.3240  | 0.3320  | 0.3150   | 0.3240   |
| E3-2     | 0.3150 | 0.3240 | 0.3240 | 0.3320 | 0.3240  | 0.3220  | 0.3160   | 0.3140   |
| E4-2     | 0.3160 | 0.3140 | 0.3240 | 0.3220 | 0.3240  | 0.3130  | 0.3170   | 0.3050   |
| E1-3     | 0.3230 | 0.3510 | 0.3330 | 0.3600 | 0.3330  | 0.3500  | 0.3230   | 0.3410   |
| E2-3     | 0.3240 | 0.3320 | 0.3330 | 0.3500 | 0.3320  | 0.3400  | 0.3240   | 0.3310   |
| E3-3     | 0.3240 | 0.3320 | 0.3320 | 0.3400 | 0.3320  | 0.3300  | 0.3240   | 0.3220   |
| E4-3     | 0.3240 | 0.3220 | 0.3320 | 0.3300 | 0.3320  | 0.3200  | 0.3240   | 0.3130   |

**Notes:**

1. Color coordinates measurement allowance is  $\pm 0.01$ .
2. One delivery will include up to two consecutive color ranks and three luminous intensity ranks of the products the quantity-ratio of the ranks is decided by **Lucky Light**.

## Reliability Test Items And Conditions:

The reliability of products shall be satisfied with items listed below:

Confidence level: 90%.

LTPD: 10%.

### 1) Test Items and Results:

| No. | Test Item                          | Test Hours/Cycles | Test Conditions                         | Sample Size | Ac/Re |
|-----|------------------------------------|-------------------|---|-------------|-------|
| 1   | Resistance to Soldering Heat       | 6 Min             | Tsld=260±5 ,<br>Min. 5sec               | 25pcs       | 0/1   |
| 2   | Thermal Shock                      | 300 Cycles        | H: +100 5min ∫ 10<br>sec<br>L: -10 5min | 25pcs       | 0/1   |
| 3   | Temperature Cycle                  | 300 Cycles        | H: +100 15min ∫<br>5min<br>L: -40 15min | 25pcs       | 0/1   |
| 4   | High Temperature Storage           | 1000Hrs.          | Temp: 100                               | 25pcs       | 0/1   |
| 5   | DC Operating Life                  | 1000Hrs.          | IF=20mA                                 | 25pcs       | 0/1   |
| 6   | Low Temperature Storage            | 1000Hrs.          | Temp: -40                               | 25pcs       | 0/1   |
| 7   | High Temperature/<br>High Humidity | 1000Hrs.          | 85 /85%RH                               | 25pcs       | 0/1   |

### 2) Criteria for Judging the Damage:

| Item               | Symbol | Test Conditions | Criteria for Judgment |            |
|--------------------|--------|-----------------|-----------------------|------------|
|                    |        |                 | Min                   | Max        |
| Forward Voltage    | VF     | IF=20mA         | ---                   | F.V.*)×1.1 |
| Reverse Current    | IR     | VR=5V           | ---                   | F.V.*)×2.0 |
| Luminous Intensity | IV     | IF=20mA         | F.V.*)×0.7            | ---        |

\*) F.V.: First Value.



Please read the following notes before using the product:

1. Over-current-proof

Customer must apply resistors for protection, otherwise slight voltage shift will cause big current change (Burn out will happen).

2. Storage

2.1 Do not open moisture proof bag before the products are ready to use.

2.2 Before opening the package, the LEDs should be kept at 30 °C or less and 80%RH or less.

2.3 The LEDs should be used within a year.

2.4 After opening the package, the LEDs should be kept at 30 °C or less and 60%RH or less.

2.5 The LEDs should be used within 168 hours (7 days) after opening the package.

2.6 If the moisture adsorbent material has fabled away or the LEDs have exceeded the storage time, baking treatment should be performed using the following conditions. Baking treatment: 60±5 °C for 24 hours.

3. Soldering Condition

When soldering, for Lamp without stopper type and must be leave a minimum of 3mm clearance from the base of the lens to the soldering point.

To avoided the Epoxy climb up on lead frame and was impact to non-soldering problem, dipping the lens into the solder must be avoided.

Do not apply any external stress to the lead frame during soldering while the LED is at high temperature.

Recommended soldering conditions:

| Soldering Iron |                                | Wave Soldering |              |
|----------------|--------------------------------|----------------|--------------|
| Temperature    | 300 °C Max.                    | Pre-heat       | 100 °C Max.  |
| Soldering Time | 3 sec. Max.<br>(one time only) | Pre-heat Time  | 60 sec. Max. |
|                |                                | Solder Wave    | 260 °C Max.  |
|                |                                | Soldering Time | 5 sec. Max.  |

Note: Excessive soldering temperature and / or time might result in deformation of the LED lens or catastrophic failure of the LED.

4. Soldering Iron

Each terminal is to go to the tip of soldering iron temperature less than 260 °C for 5 seconds within once in less than the soldering iron capacity 25W. Leave two seconds and more intervals, and do soldering of each terminal. Be careful because the damage of the product is often started at the time of the hand solder.

5. Repairing

Repair should not be done after the LEDs have been soldered. When repairing is unavoidable, a double-head soldering iron should be used (as below figure). It should be confirmed beforehand whether the characteristics of the LEDs will or will not be damaged by repairing.

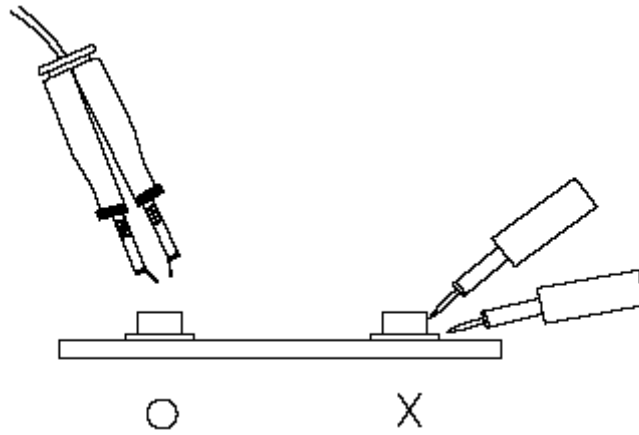

#### 6. Caution in ESD

Static Electricity and surge damages the LED. It is recommended to use a wrist band or anti-electrostatic glove when handling the LED. All devices, equipment and machinery must be properly grounded.