

4.8mm Round Wide Viewing Angle Type
White LED
Technical Data Sheet

Part No.: 484WC1C-W5-1P



Features:

Wide viewing angle=100°.

Reliable and robust.

Emission color: X=0.35, y=0.36.

Industrial standard footprint.

The product itself will remain within RoHS compliant version.

Descriptions:

The series is specially designed for applications requiring higher brightness.

The LED lamps are available with different colors.

The white LED which was fabricated using a blue LED and a phosphor, and the phosphor is excited by blue light and emits yellow fluorescence, the mixture of blue light and yellow light results in white emission.

Utilizing advanced InGaN chip technology.

Applications:

TV set.

Monitor.

Telephone.

Computer.

Circuit board.

Status indicators.

Commercial use.

Advertising Signs.

Back lighting.

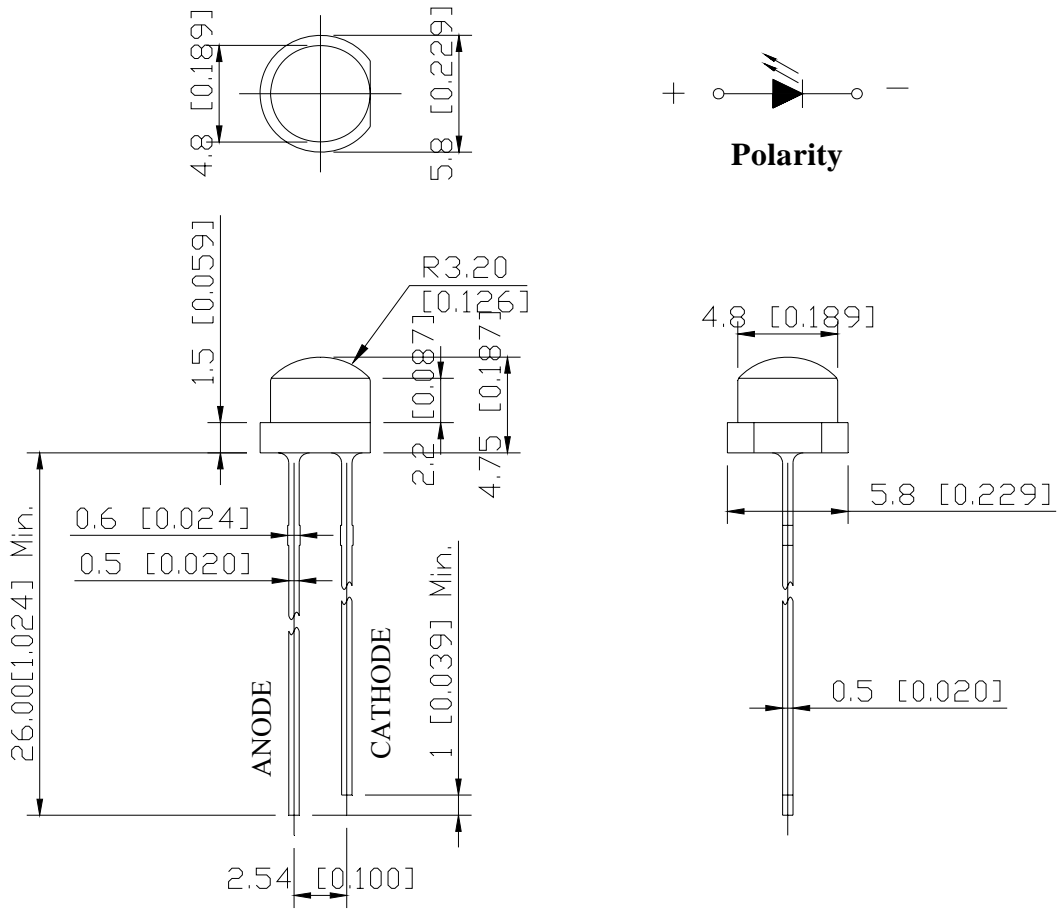
Package Dimension:

| Part No. | Chip Material | Lens Color | Source Color |
|---------------|---------------|-------------|--------------|
| 484WC1C-W5-1P | InGaN | Water Clear | White |

Notes:

1. All dimensions are in millimeters (inches).
2. Tolerance is ± 0.25 mm (.010") unless otherwise noted.
3. Protruded resin under flange is 1.00 mm (.039") max.
4. Specifications are subject to change without notice.

Absolute Maximum Ratings at Ta=25

| Parameters | Symbol | Max. | Unit |
|--|--------|-------------------|------|
| Power Dissipation | PD | 95 | mW |
| Peak Forward Current (1/10 Duty Cycle, 0.1ms Pulse Width) | IFP | 100 | mA |
| Forward Current | IF | 25 | mA |
| Reverse Voltage | VR | 5 | V |
| Electrostatic Discharge (HBM) | ESD | 400 | V |
| Operating Temperature Range | Topr | -40 to +85 | |
| Storage Temperature Range | Tstg | -40 to +100 | |
| Lead Soldering Temperature [4mm (.157") From Body] | Tsld | 260 for 5 Seconds | |

Electrical Optical Characteristics at Ta=25

| Parameters | Symbol | Min. | Typ. | Max. | Unit | Test Condition |
|--------------------------|-----------------|------|------|------|---------|------------------|
| Luminous Intensity * | IV | 1300 | 1700 | --- | mcd | IF=20mA (Note 1) |
| Viewing Angle * | $2\theta_{1/2}$ | --- | 100 | --- | Deg | IF=20mA (Note 2) |
| Chromaticity Coordinates | x | --- | 0.35 | --- | | IF=20mA (Note 3) |
| | y | --- | 0.36 | --- | | |
| Color Temperature | CCT | 3800 | 4500 | 5500 | K | IF=20mA |
| Forward Voltage | VF | 2.80 | 3.30 | 3.80 | V | IF=20mA |
| Reverse Current | IR | --- | --- | 10 | μ A | VR=5V |

Notes:

1. Luminous Intensity Measurement allowance is $\pm 10\%$.
2. $\theta_{1/2}$ is the off-axis angle at which the luminous intensity is half the axial luminous intensity.
3. It use many parameters that correspond to the CIE 1931 2°. X, Y, and Z are CIE 1931 2° values of Red, Green and Blue content of the measurement.

Typical Electrical / Optical Characteristics Curves
(25 Ambient Temperature Unless Otherwise Noted)

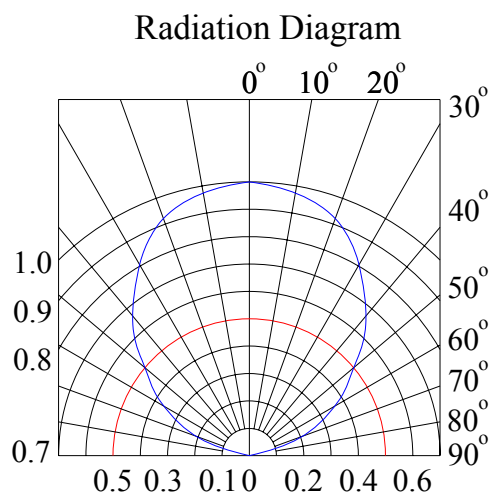
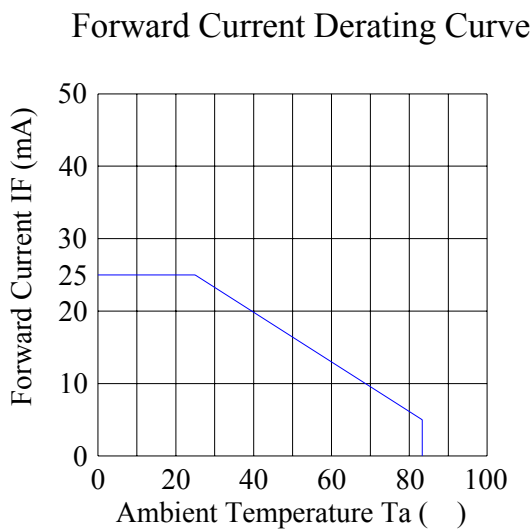
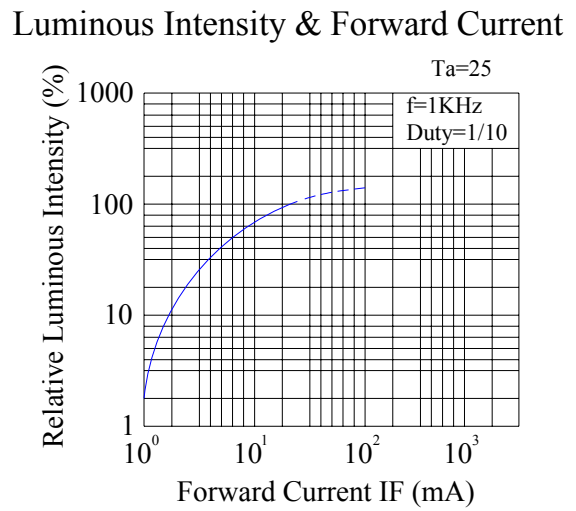
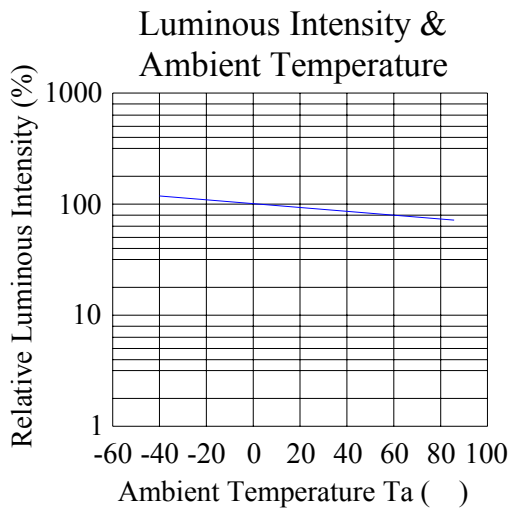
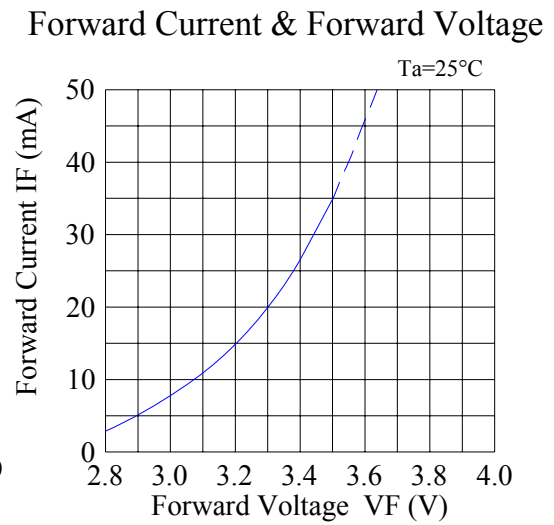
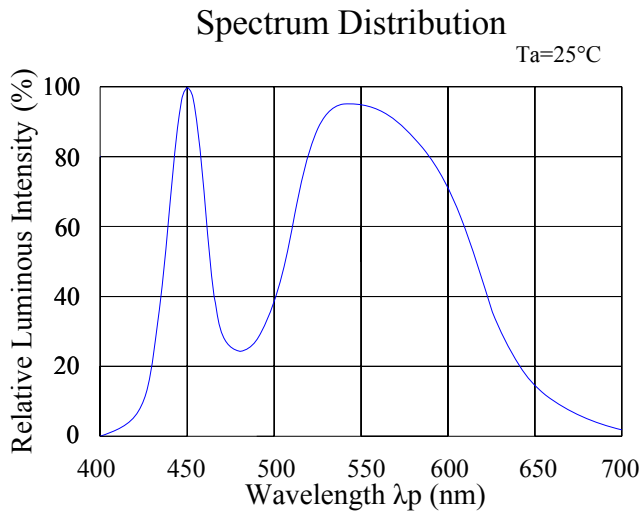

CIE 1931 Chromaticity Diagram:

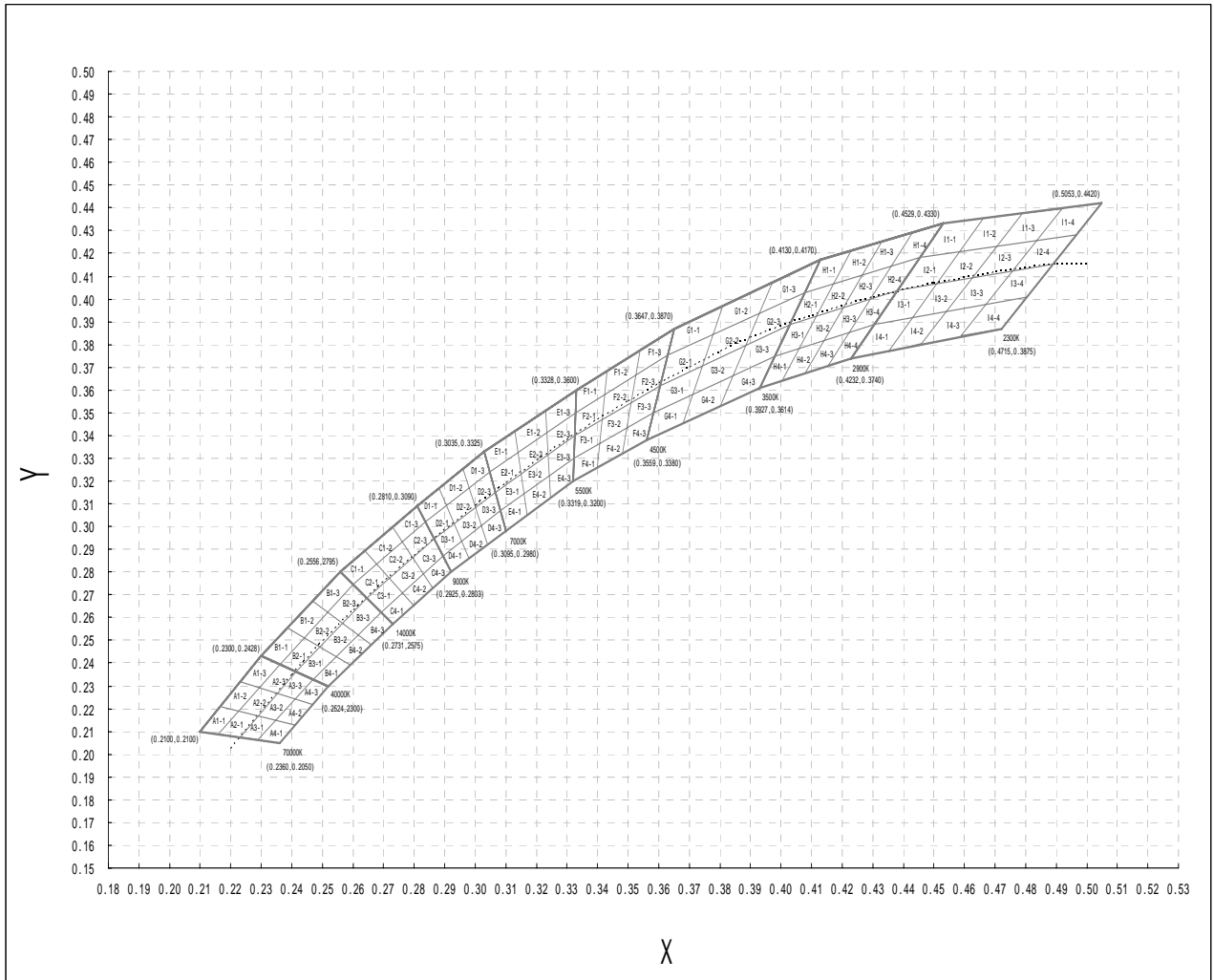

W5:

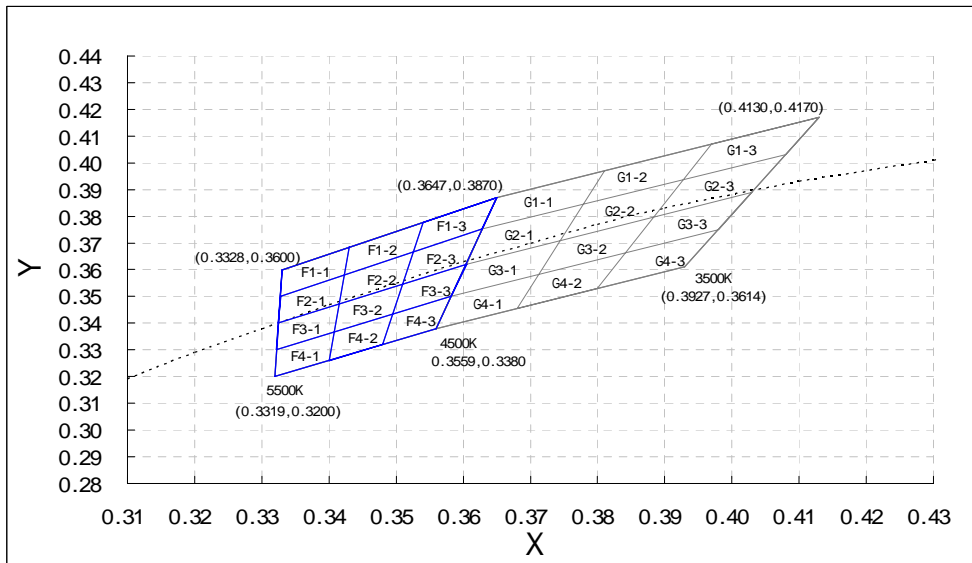

Chromaticity Coordinates Specifications for Bin Rank:

| Bin Code | Left x | Left y | Top x | Top y | Right x | Right y | Bottom x | Bottom y |
|----------|--------|--------|--------|--------|---------|---------|----------|----------|
| F1-1 | 0.3330 | 0.3600 | 0.3430 | 0.3690 | 0.3430 | 0.3580 | 0.3330 | 0.3500 |
| F2-1 | 0.3330 | 0.3500 | 0.3430 | 0.3580 | 0.3420 | 0.3480 | 0.3320 | 0.3400 |
| F3-1 | 0.3320 | 0.3400 | 0.3420 | 0.3480 | 0.3410 | 0.3370 | 0.3320 | 0.3300 |
| F4-1 | 0.3320 | 0.3300 | 0.3410 | 0.3370 | 0.3400 | 0.3260 | 0.3320 | 0.3200 |
| F1-2 | 0.3430 | 0.3690 | 0.3540 | 0.3780 | 0.3530 | 0.3660 | 0.3430 | 0.3580 |
| F2-2 | 0.3430 | 0.3580 | 0.3530 | 0.3660 | 0.3510 | 0.3550 | 0.3420 | 0.3480 |
| F3-2 | 0.3420 | 0.3480 | 0.3510 | 0.3550 | 0.3490 | 0.3430 | 0.3410 | 0.3370 |
| F4-2 | 0.3410 | 0.3370 | 0.3490 | 0.3430 | 0.3480 | 0.3320 | 0.3400 | 0.3260 |
| F1-3 | 0.3540 | 0.3780 | 0.3650 | 0.3870 | 0.3620 | 0.3750 | 0.3530 | 0.3660 |
| F2-3 | 0.3530 | 0.3660 | 0.3620 | 0.3750 | 0.3600 | 0.3620 | 0.3510 | 0.3550 |
| F3-3 | 0.3510 | 0.3550 | 0.3600 | 0.3620 | 0.3580 | 0.3500 | 0.3490 | 0.3430 |
| F4-3 | 0.3490 | 0.3430 | 0.3580 | 0.3500 | 0.3560 | 0.3380 | 0.3480 | 0.3320 |
| G1-1 | 0.3650 | 0.3870 | 0.3810 | 0.3970 | 0.3780 | 0.3840 | 0.3620 | 0.3750 |
| G2-1 | 0.3620 | 0.3750 | 0.3780 | 0.3840 | 0.3740 | 0.3710 | 0.3600 | 0.3620 |
| G3-1 | 0.3600 | 0.3620 | 0.3740 | 0.3710 | 0.3710 | 0.3590 | 0.3580 | 0.3500 |
| G4-1 | 0.3580 | 0.3500 | 0.3710 | 0.3590 | 0.3680 | 0.3460 | 0.3560 | 0.3380 |
| G1-2 | 0.3810 | 0.3970 | 0.3970 | 0.4070 | 0.3930 | 0.3940 | 0.3780 | 0.3840 |
| G2-2 | 0.3780 | 0.3840 | 0.3930 | 0.3940 | 0.3890 | 0.3800 | 0.3740 | 0.3710 |
| G3-2 | 0.3740 | 0.3710 | 0.3890 | 0.3800 | 0.3850 | 0.3670 | 0.3710 | 0.3590 |
| G4-2 | 0.3710 | 0.3590 | 0.3850 | 0.3670 | 0.3800 | 0.3540 | 0.3680 | 0.3460 |
| G1-3 | 0.3970 | 0.4070 | 0.4130 | 0.4170 | 0.4080 | 0.4030 | 0.3930 | 0.3940 |
| G2-3 | 0.3930 | 0.3940 | 0.4080 | 0.4030 | 0.4030 | 0.3890 | 0.3890 | 0.3800 |
| G3-3 | 0.3890 | 0.3800 | 0.4030 | 0.3890 | 0.3980 | 0.3750 | 0.3850 | 0.3670 |
| G4-3 | 0.3850 | 0.3670 | 0.3980 | 0.3750 | 0.3930 | 0.3610 | 0.3800 | 0.3540 |

Notes:

1. Color coordinates measurement allowance is ± 0.15 .
2. One delivery will include up to two consecutive color ranks and three luminous intensity ranks of the products the quantity-ratio of the ranks is decided by **LuckyLight**.

Reliability Test Items And Conditions:

The reliability of products shall be satisfied with items listed below:

Confidence level: 90%.

LTPD: 10%.

1) Test Items and Results:

| Test Item | Standard Test Method | Test Conditions | Note | Number of Damaged |
|---|--------------------------|--|----------------------|-------------------|
| Resistance to Soldering Heat | JEITA ED-4701 300 302 | Tsld=260±5 , 10sec 3mm from the base of the epoxy bulb | 1 time | 0/100 |
| Solder ability | JEITA ED-4701 300 303 | Tsld=235±5 , 5sec (using flux) | 1time over 95% | 0/100 |
| Thermal Shock | JEITA ED-4701 300 307 | 0 ~100 15sec, 15sec | 100 cycles | 0/100 |
| Temperature Cycle | JEITA ED-4701 100 105 | -40 ~25 ~100 ~25 30min,5min,30min,5min | 100 cycles | 0/100 |
| Moisture Resistance Cycle | JEITA ED-4701 200 203 | 25 ~65 ~-10 90%RH 24hrs/1cycle | 10 cycles | 0/100 |
| High Temperature Storage | JEITA ED-4701 200 201 | Ta=100 | 1000hrs | 0/100 |
| Terminal Strength (Pull test) | JEITA ED-4701 400 401 | Load 10N (1kgf) 10±1sec | No noticeable damage | 0/100 |
| Terminal Strength (bending test) | JEITA ED-4701 400 401 | Load 5N (0.5kgf) 0°~90°~0° bend 2 times | No noticeable damage | 0/100 |
| Temperature Humidity Storage | JEITA ED-4701 100 103 | Ta=60 , RH=90% | 1000hrs | 0/100 |
| Low Temperature Storage | JEITA ED-4701 200 202 | Ta=-40 | 1000hrs | 0/100 |
| Steady State Operating Life | | Ta=25 , IF=20mA | 1000hrs | 0/100 |
| Steady State Operating Life of High Humidity Heat | | Ta=60 , RH=90%, IF=20mA | 500hrs | 0/100 |
| Steady State Operating Life of Low Temperature | | Ta=-30 , IF=30mA | 1000hrs | 0/100 |

2) Criteria for Judging the Damage:

| Item | Symbol | Test Conditions | Criteria for Judgment | |
|--------------------|--------|-----------------|-----------------------|------------|
| | | | Min | Max |
| Forward Voltage | VF | IF=20mA | --- | F.V.*)×1.1 |
| Reverse Current | IR | VR=5V | --- | F.V.*)×2.0 |
| Luminous Intensity | IV | IF=20mA | F.V.*)×0.7 | --- |

*) F.V.: First Value.

Please read the following notes before using the product:

1. Over-current-proof

Customer must apply resistors for protection, otherwise slight voltage shift will cause big current change (Burn out will happen).

2. Storage

2.1 Do not open moisture proof bag before the products are ready to use.

2.2 Before opening the package, the LEDs should be kept at 30 °C or less and 80%RH or less.

2.3 The LEDs should be used within a year.

2.4 After opening the package, the LEDs should be kept at 30 °C or less and 60%RH or less.

2.5 The LEDs should be used within 168 hours (7 days) after opening the package.

3. Soldering Iron

Each terminal is to go to the tip of soldering iron temperature less than 260 °C for 5 seconds within once in less than the soldering iron capacity 25W. Leave two seconds and more intervals, and do soldering of each terminal. Be careful because the damage of the product is often started at the time of the hand solder.

4. Soldering

When soldering, for Lamp without stopper type and must be leave a minimum of 3mm clearance from the base of the lens to the soldering point.

To avoided the Epoxy climb up on lead frame and was impact to non-soldering problem, dipping the lens into the solder must be avoided.

Do not apply any external stress to the lead frame during soldering while the LED is at high temperature.

Recommended soldering conditions:

| Soldering Iron | | Wave Soldering | |
|----------------|--------------------------------|----------------|--------------|
| Temperature | 300 Max. | Pre-heat | 100 Max. |
| Soldering Time | 3 sec. Max. (one time only) | Pre-heat Time | 60 sec. Max. |
| | | Solder Wave | 260 Max. |
| | | Soldering Time | 5 sec. Max. |

Note: Excessive soldering temperature and / or time might result in deformation of the LED lens or catastrophic failure of the LED.

5. Repairing

Repair should not be done after the LEDs have been soldered. When repairing is unavoidable, a double-head soldering iron should be used. It should be confirmed beforehand whether the characteristics of the LEDs will or will not be damaged by repairing.

6. Caution in ESD

Static Electricity and surge damages the LED. It is recommended to use a wrist band or anti-electrostatic glove when handling the LED. All devices equipment and machinery must be properly grounded.