

3mm Round With Flange Type
White LED
Technical Data Sheet

Part No.: 304WC2J-W5-3PD



Features:

- Popular T-1 diameter package.
- High efficiency.
- Reliable and robust.
- Emission color: $X=0.35$, $y=0.36$.
- Industrial standard footprint.
- The product itself will remain within RoHS compliant Version.

Descriptions:

- The series is specially designed for applications requiring higher brightness.
- The LED lamps are available with different colors, intensities.
- The white LED which was fabricated using a blue LED and a phosphor, and the phosphor is excited by blue light and emits yellow fluorescence, the mixture of blue light and yellow light results in white emission.
- Utilizing advanced InGaN chip technology.

Applications:

- QA equipment.
- Backlighting of LCD.
- Automotive equipment.
- Replacement of conventional Light bulbs and fluorescent lamps.
- Indoor and out door displays, etc.

Package Dimension:

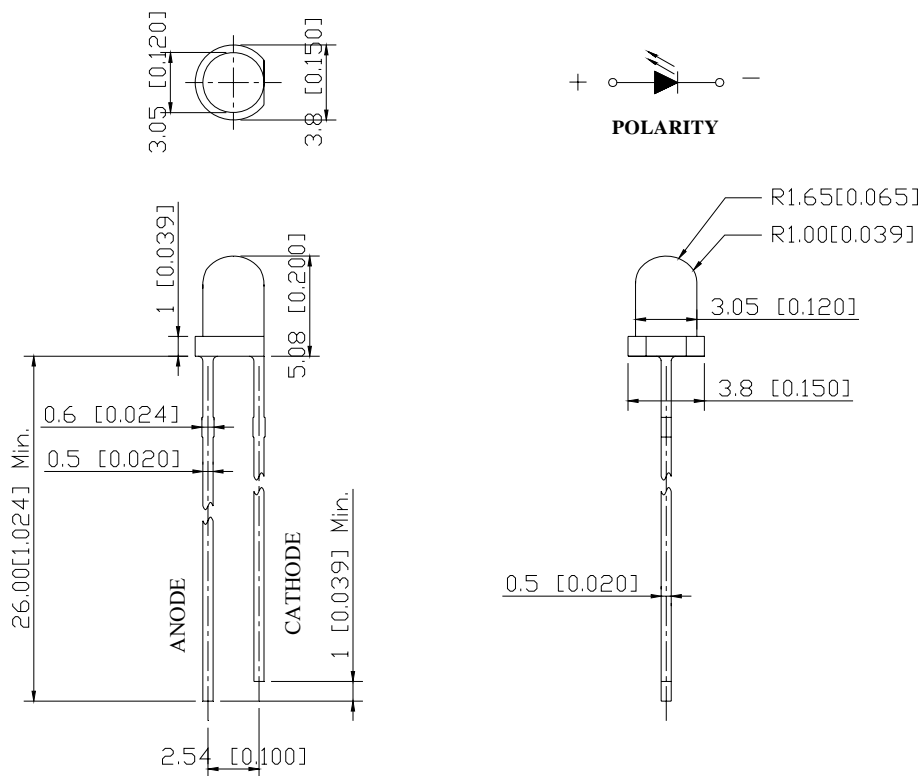

Part No.	Chip Material	Lens Color	Source Color
304WC2J-W5-3PD	InGaN	Water Clear	White

Notes:

1. All dimensions are in millimeters (inches).
2. Tolerance is ± 0.25 mm (.010") unless otherwise noted.
3. Protruded resin under flange is 1.00 mm (.039") max.
4. Specifications are subject to change without notice.

Absolute Maximum Ratings at Ta=25

Parameters	Symbol	Max.	Unit
Power Dissipation	PD	95	mW
Peak Forward Current (1/10 Duty Cycle, 0.1ms Pulse Width)	IFP	100	mA
Forward Current	IF	25	mA
Reverse Voltage	VR	5	V
Electrostatic Discharge (HBM)	ESD	400	V
Operating Temperature Range	Topr	-40 to +85	
Storage Temperature Range	Tstg	-40 to +100	
Lead Soldering Temperature [4mm (.157") From Body]	Tsld	260 for 5 Seconds	

Electrical Optical Characteristics at Ta=25

Parameters	Symbol	Min.	Typ.	Max.	Unit	Test Condition
Luminous Intensity *	IV	8500	11000	---	mcd	IF=20mA (Note 1)
Viewing Angle *	$2\theta_{1/2}$	---	30	---	Deg	IF=20mA (Note 2)
Chromaticity Coordinates	x	---	0.35	---		IF=20mA (Note 3)
	y	---	0.36	---		
Color Temperature	CCT	3800	4500	5500	K	IF=20mA
Forward Voltage	VF	2.80	3.30	3.80	V	IF=20mA
Reverse Current	IR	---	---	10	μ A	VR=5V

Notes:

- Luminous Intensity Measurement allowance is $\pm 10\%$.
- $\theta_{1/2}$ is the off-axis angle at which the luminous intensity is half the axial luminous intensity.
- It use many parameters that correspond to the CIE 1931 2°. X, Y, and Z are CIE 1931 2° values of Red, Green and Blue content of the measurement.

Typical Electrical / Optical Characteristics Curves
(25 Ambient Temperature Unless Otherwise Noted)

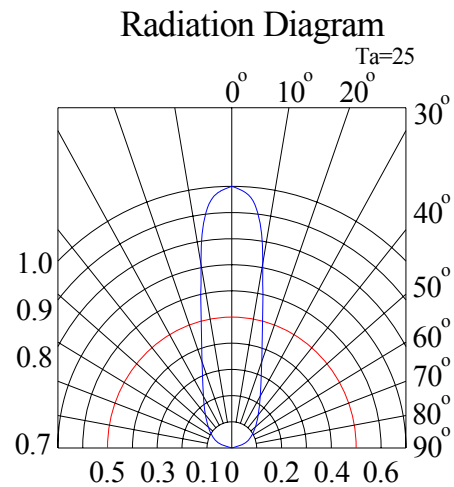
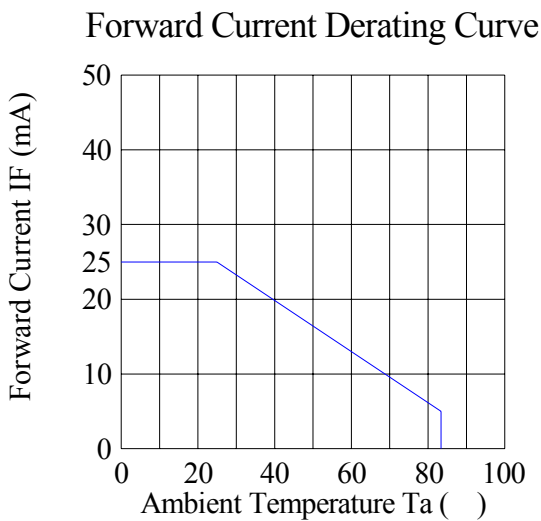
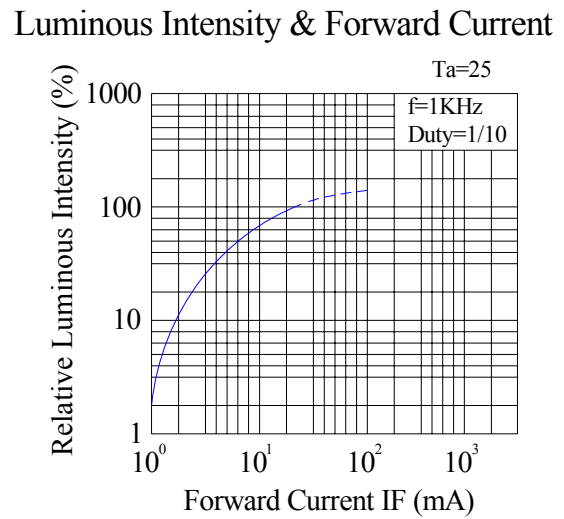
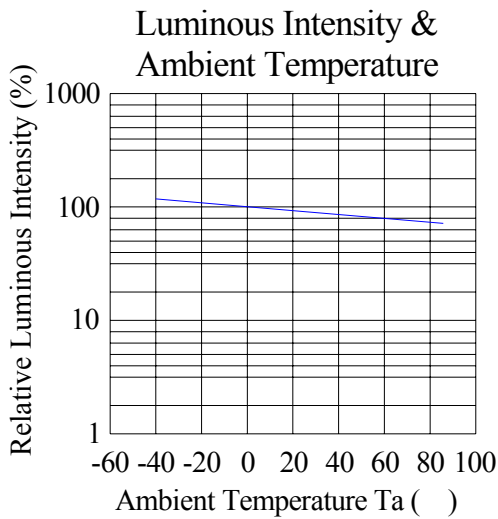
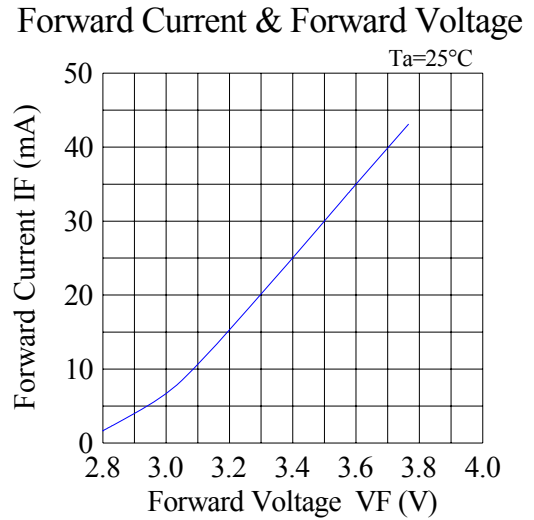
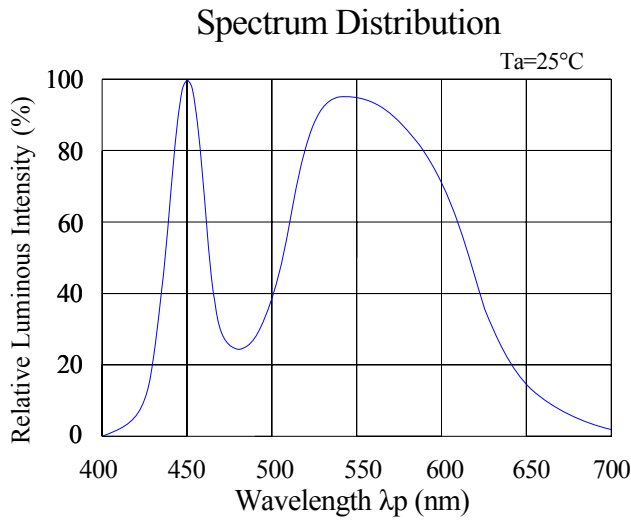

CIE 1931 Chromaticity Diagram:

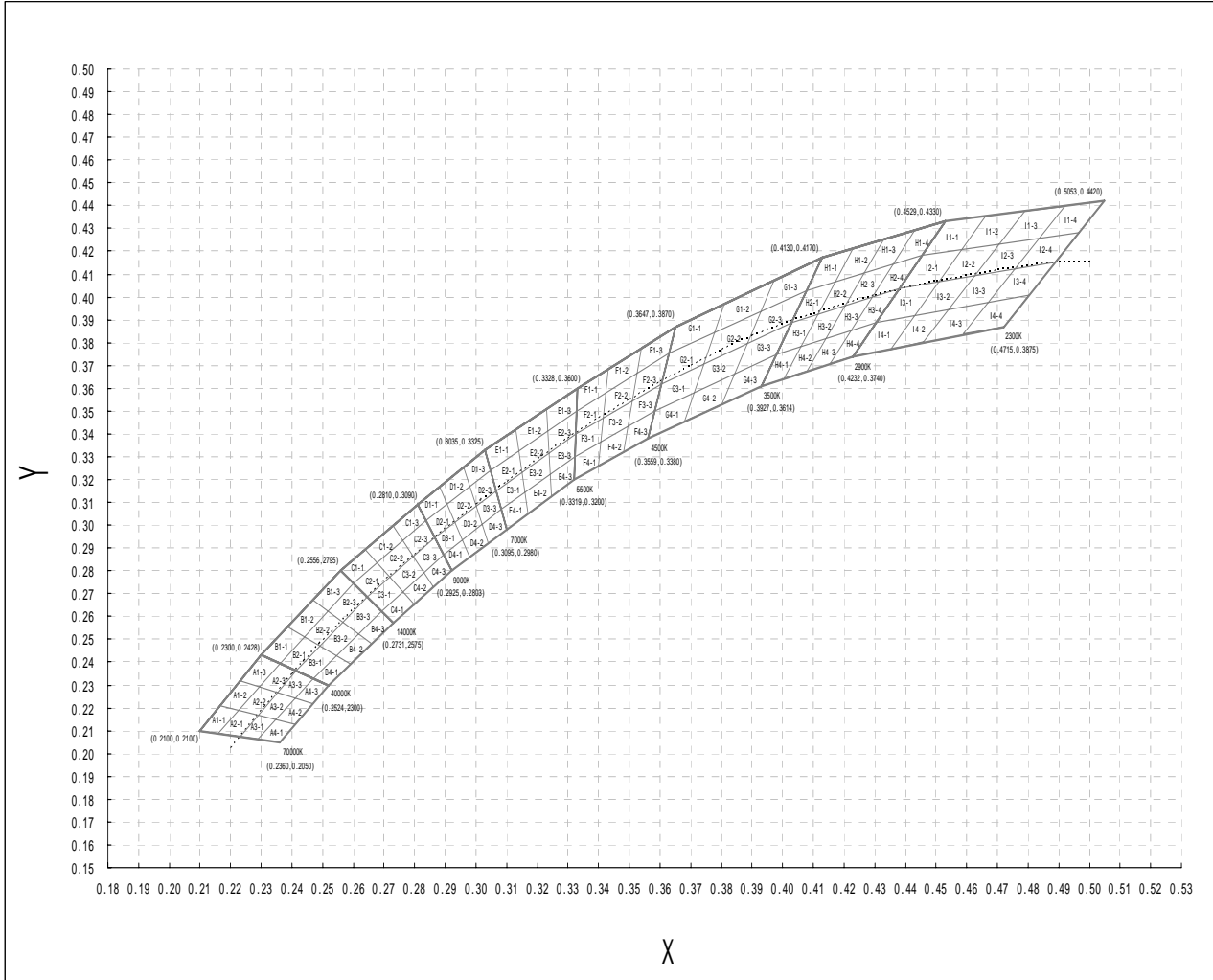

W5:

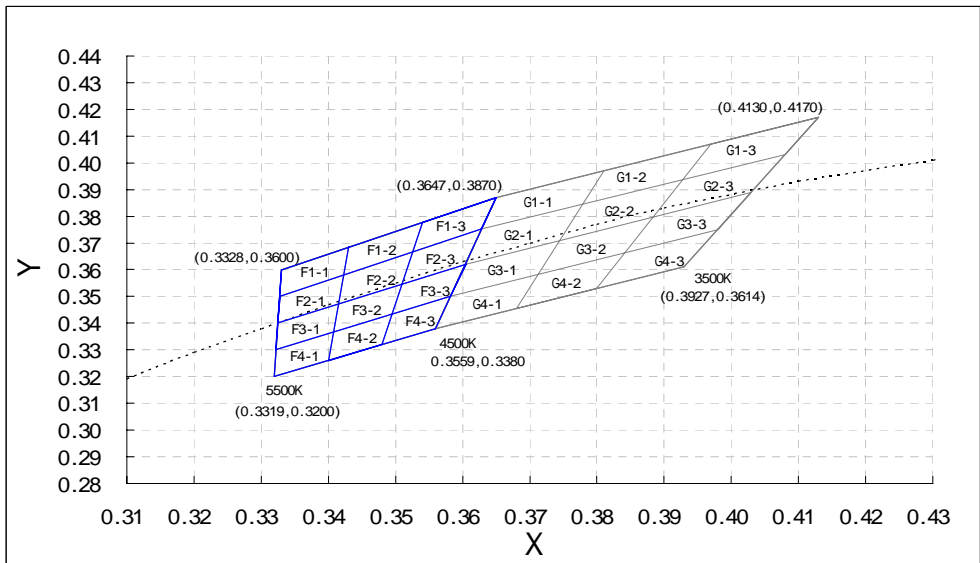

Chromaticity Coordinates Specifications for Bin Rank:

Bin Code	Left x	Left y	Top x	Top y	Right x	Right y	Bottom x	Bottom y
F1-1	0.3330	0.3600	0.3430	0.3690	0.3430	0.3580	0.3330	0.3500
F2-1	0.3330	0.3500	0.3430	0.3580	0.3420	0.3480	0.3320	0.3400
F3-1	0.3320	0.3400	0.3420	0.3480	0.3410	0.3370	0.3320	0.3300
F4-1	0.3320	0.3300	0.3410	0.3370	0.3400	0.3260	0.3320	0.3200
F1-2	0.3430	0.3690	0.3540	0.3780	0.3530	0.3660	0.3430	0.3580
F2-2	0.3430	0.3580	0.3530	0.3660	0.3510	0.3550	0.3420	0.3480
F3-2	0.3420	0.3480	0.3510	0.3550	0.3490	0.3430	0.3410	0.3370
F4-2	0.3410	0.3370	0.3490	0.3430	0.3480	0.3320	0.3400	0.3260
F1-3	0.3540	0.3780	0.3650	0.3870	0.3620	0.3750	0.3530	0.3660
F2-3	0.3530	0.3660	0.3620	0.3750	0.3600	0.3620	0.3510	0.3550
F3-3	0.3510	0.3550	0.3600	0.3620	0.3580	0.3500	0.3490	0.3430
F4-3	0.3490	0.3430	0.3580	0.3500	0.3560	0.3380	0.3480	0.3320
G1-1	0.3650	0.3870	0.3810	0.3970	0.3780	0.3840	0.3620	0.3750
G2-1	0.3620	0.3750	0.3780	0.3840	0.3740	0.3710	0.3600	0.3620
G3-1	0.3600	0.3620	0.3740	0.3710	0.3710	0.3590	0.3580	0.3500
G4-1	0.3580	0.3500	0.3710	0.3590	0.3680	0.3460	0.3560	0.3380
G1-2	0.3810	0.3970	0.3970	0.4070	0.3930	0.3940	0.3780	0.3840
G2-2	0.3780	0.3840	0.3930	0.3940	0.3890	0.3800	0.3740	0.3710
G3-2	0.3740	0.3710	0.3890	0.3800	0.3850	0.3670	0.3710	0.3590
G4-2	0.3710	0.3590	0.3850	0.3670	0.3800	0.3540	0.3680	0.3460
G1-3	0.3970	0.4070	0.4130	0.4170	0.4080	0.4030	0.3930	0.3940
G2-3	0.3930	0.3940	0.4080	0.4030	0.4030	0.3890	0.3890	0.3800
G3-3	0.3890	0.3800	0.4030	0.3890	0.3980	0.3750	0.3850	0.3670
G4-3	0.3850	0.3670	0.3980	0.3750	0.3930	0.3610	0.3800	0.3540

Notes:

1. Color coordinates measurement allowance is ± 0.15 .
2. One delivery will include up to two consecutive color ranks and three luminous intensity ranks of the products the quantity-ratio of the ranks is decided by **LuckyLight**.

Reliability Test Items And Conditions:

The reliability of products shall be satisfied with items listed below:

Confidence level: 90%.

LTPD: 10%.

1) Test Items and Results:

Test Item	Standard Test Method	Test Conditions	Note	Number of Damaged
Resistance to Soldering Heat	JEITA ED-4701 300 302	Tsld=260±5 , 10sec 3mm from the base of the epoxy bulb	1 time	0/100
Solder ability	JEITA ED-4701 300 303	Tsld=235±5 , 5sec (using flux)	1time over 95%	0/100
Thermal Shock	JEITA ED-4701 300 307	0 ~100 15sec, 15sec	100 cycles	0/100
Temperature Cycle	JEITA ED-4701 100 105	-40 ~25 ~100 ~25 30min,5min,30min,5min	100 cycles	0/100
Moisture Resistance Cycle	JEITA ED-4701 200 203	25 ~65 ~-10 90%RH 24hrs/1cycle	10 cycles	0/100
High Temperature Storage	JEITA ED-4701 200 201	Ta=100	1000hrs	0/100
Terminal Strength (Pull test)	JEITA ED-4701 400 401	Load 10N (1kgf) 10±1sec	No noticeable damage	0/100
Terminal Strength (bending test)	JEITA ED-4701 400 401	Load 5N (0.5kgf) 0°~90°~0° bend 2 times	No noticeable damage	0/100
Temperature Humidity Storage	JEITA ED-4701 100 103	Ta=60 , RH=90%	1000hrs	0/100
Low Temperature Storage	JEITA ED-4701 200 202	Ta=-40	1000hrs	0/100
Steady State Operating Life		Ta=25 , IF=20mA	1000hrs	0/100
Steady State Operating Life of High Humidity Heat		Ta=60 , RH=90%, IF=20mA	500hrs	0/100
Steady State Operating Life of Low Temperature		Ta=-30 , IF=30mA	1000hrs	0/100

2) Criteria for Judging the Damage:

Item	Symbol	Test Conditions	Criteria for Judgment	
			Min	Max
Forward Voltage	VF	IF=20mA	---	F.V.*)×1.1
Reverse Current	IR	VR=5V	---	F.V.*)×2.0
Luminous Intensity	IV	IF=20mA	F.V.*)×0.7	---

*) F.V.: First Value.

Please read the following notes before using the product:

1. Over-current-proof

Customer must apply resistors for protection, otherwise slight voltage shift will cause big current change (Burn out will happen).

2. Storage

2.1 Do not open moisture proof bag before the products are ready to use.

2.2 Before opening the package, the LEDs should be kept at 30 °C or less and 80%RH or less.

2.3 The LEDs should be used within a year.

2.4 After opening the package, the LEDs should be kept at 30 °C or less and 60%RH or less.

2.5 The LEDs should be used within 168 hours (7 days) after opening the package.

3. Soldering Iron

Each terminal is to go to the tip of soldering iron temperature less than 260 °C for 5 seconds within once in less than the soldering iron capacity 25W. Leave two seconds and more intervals, and do soldering of each terminal. Be careful because the damage of the product is often started at the time of the hand solder.

4. Soldering

When soldering, for Lamp without stopper type and must be leave a minimum of 3mm clearance from the base of the lens to the soldering point.

To avoided the Epoxy climb up on lead frame and was impact to non-soldering problem, dipping the lens into the solder must be avoided.

Do not apply any external stress to the lead frame during soldering while the LED is at high temperature.

Recommended soldering conditions:

Soldering Iron		Wave Soldering	
Temperature	300 Max.	Pre-heat	100 Max.
Soldering Time	3 sec. Max. (one time only)	Pre-heat Time	60 sec. Max.
		Solder Wave	260 Max.
		Soldering Time	5 sec. Max.

Note: Excessive soldering temperature and / or time might result in deformation of the LED lens or catastrophic failure of the LED.

5. Repairing

Repair should not be done after the LEDs have been soldered. When repairing is unavoidable, a double-head soldering iron should be used. It should be confirmed beforehand whether the characteristics of the LEDs will or will not be damaged by repairing.

6. Caution in ESD

Static Electricity and surge damages the LED. It is recommended to use a wrist band or anti-electrostatic glove when handling the LED. All devices equipment and machinery must be properly grounded.